

Buttweld Fittings

ANSI B16.9, ANSI B16.28, MSS-SP-43, MSS-SP-95, MSS-SP-97

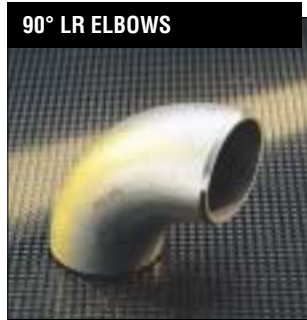

Concentric and eccentric reducers, equal and reducing tees, 45° and 90° elbows, buttweld caps and stub ends, are all part of the comprehensive range of buttweld fittings carried by Prochem.

Stocks include dual grades 304/304L, 316/316L and 321/321H austenitic stainless steel, in sizes 15NB (½") through to 400NB (16") in SCH 10S, SCH 40S and SCH 80S. Larger sizes and heavier schedules, such as SCH160 or SCHXXS, are readily available through our worldwide network.

All our buttweld fittings conform to relevant material and dimensional specifications and can be supplied complete with material certificates.

Buttweld fittings in duplex and other special alloys are available from stock and throughout our worldwide network of suppliers.



Buttweld Fittings

A pipe fitting is defined as a part used in a piping system, to change direction or function, which is mechanically joined to the system.

Probably the simplest way to achieve this would be to bend the pipe in the direction required, but this process will stretch and thin the outer wall whilst thickening and wrinkling the inner wall. This results in flow resistance and accelerated wall erosion.

A second method sometimes used is a mitre joint, where pipes are cut to the correct angle and welded together to achieve the desired change. Whilst the cross-sectional area and wall thickness are maintained, a great deal of efficiency is lost due to friction and turbulence resulting from the severe changes in direction. For example, a single-mitre bend offers about six times the resistance of a swept elbow.

For these reasons swept fittings are preferred on most piping systems, particularly where internal pressure, flow and corrosion are of major consideration.

TYPES AND APPLICATIONS OF BUTTWELD FITTINGS

A piping system using buttweld fittings has many inherent advantages over other forms.

- Welding a fitting to the pipe means it is permanently leakproof.
- The continuous metal structure formed between pipe and fitting adds strength to the system.
- Smooth inner surface and gradual directional changes reduce pressure losses and turbulence and minimise the action of corrosion and erosion.
- A welded system utilises a minimum of space.

90° ELBOWS

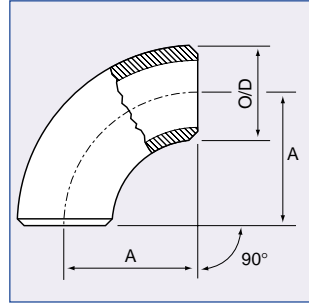

The function of a 90° elbow is to change direction or flow in a piping system.

Elbows are split into three groups which define the distance over which they change direction, expressed as a function of the distance from the centre line of one end to the opposite face.

This is known as the centre to face distance and is equivalent to the radius through which the elbow is bent.

Long Radius Elbow

The most common is the long radius (L.R.) elbow where the centre to face dimension is always 1½ times the nominal pipe size of the elbow.

Short Radius Elbow

In this case the centre to face dimension is the same as the nominal pipe size of the elbow.

Extra Long Radius

This is where the centre to face dimension is longer than the standard long radius type. The most common of these is where the centre to face dimension is three times the nominal size. i.e. 3D.

45° ELBOWS

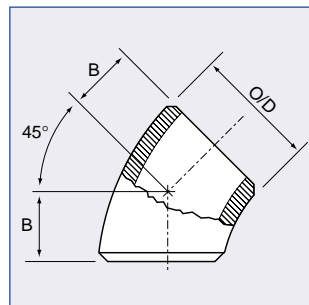

The function of a 45° elbow is the same as a 90° elbow, but the measurement of dimensions, however, is different to that of the 90° elbow. The radius of a 45° elbow is the same as the radius of the 90° L.R. elbow where 'R' equals 1½D.

However, the centre to face dimension is not equivalent to the radius as in 90° L.R. elbows. This is measured from each face to the point of intersection of the centre lines perpendicular to each other. This is due to the smaller degree of bend.

180° RETURN BENDS

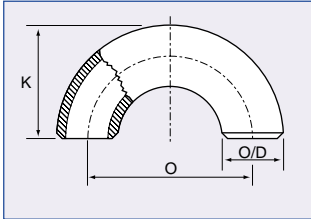

The function of a 180° return bend is to change direction of flow through 180° and there are two basic types, long radius and short radius. Both types have a centre to centre dimension double the matching 90° elbows. The

primary application for these fittings is in heater coils and heat exchangers, boilers etc.

ECCENTRIC AND CONCENTRIC REDUCERS

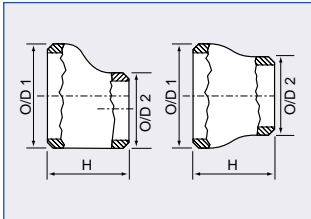

The function of both types of reducer is to reduce the line from a larger to a smaller pipe size, this obviously results in an increased flow pressure. With the eccentric reducer the smaller outlet end is off centre to the larger end enabling it to

line up with one side of the inlet and not with the other.

The concentric reducer is so manufactured that both inlet and outlet ends are on a common centre line. The concentric reducer is easier and less expensive to produce but does not allow quite the same versatility as the eccentric reducer. The lengths of both types are fixed by manufacturing standards.

EQUAL AND REDUCING TEES

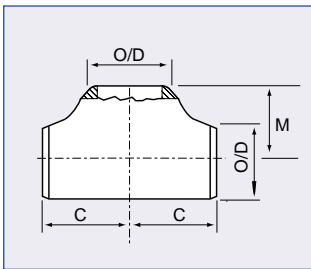

The function of a tee is to permit flow at 90° to the main direction of flow. The main flow passes through the 'run' whilst the 90° outlet is known as the 'branch'. The equal tee is manufactured with all three outlets being the same size.

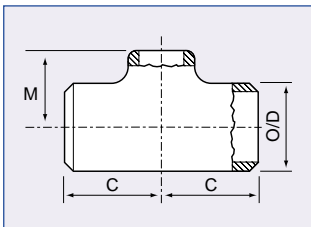

The reducing tee is manufactured with the branch outlet smaller than the run to obtain the desired flow and pressure through the system.

EQUAL AND REDUCING CROSSES

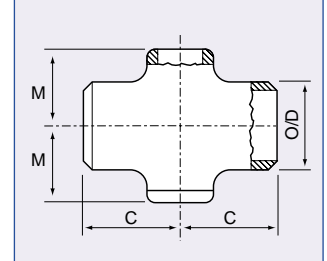
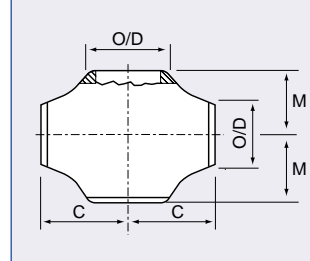

The function of a cross is similar to that of a tee with the exception of providing two 90° outlets opposite each other. Equal crosses have all four outlets of equal size. Reducing crosses have branches that are smaller in size to that of the run to obtain the desired flow and pressure through the system.

CAPS

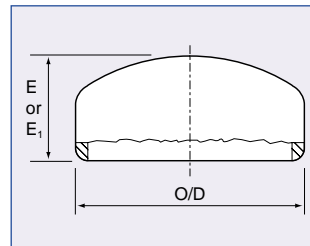

The function of an end cap is to block off the end of a line in piping systems. This is achieved by placing the end cap over the open line and welding around the joint.

LAP JOINT STUB ENDS

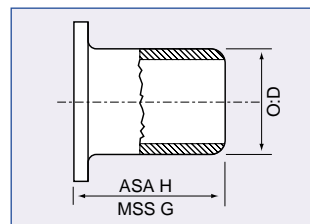

A lap joint stub end and its associated slip-on flange in a piping system allows quick disconnection of the particular section involved. Stub ends are installed in pairs and mated together with two lap joint flanges.

The surface of the stub end has a phonographic serrated gasket surface which prevents leakage at the joint. Using stub ends allows sections of the line to be opened for cleaning, inspection or quick replacement etc., without the need to re-weld.

There are two basic types of stub end, ANSI types A & B long barrel, and M.S.S. types short barrel. Under certain design criteria such as temperature or pressure, etc., it is not acceptable to have the joint between stub end and pipe in close proximity with the flange joint, in these applications ANSI types are used.

BUTTWELD FITTINGS WEIGHTS & DIMENSIONS

NOMINAL SIZE		WT SCH	90° LR ELBOW		45° LR ELBOW		EQUAL TEE		CAPS	
Inches	Metric		A	Wgt	B	Wgt	C/M	Wgt	E	Wgt
1/2	15	10S	38.1	0.06	15.9	0.03	25.4	0.09	25.4	0.04
		40S	38.1	0.08	15.9	0.04	25.4	0.16	25.4	0.03
		80S	38.1	0.10	15.9	0.05	25.4	0.25	25.4	0.05
		160S	38.1	0.12	15.9	0.06	25.4	0.16	25.4	0.06
		XXS	38.1	0.17	15.9	0.08	25.4	0.23	25.4	0.08
3/4*	20*	10S	28.6	0.07	11.1	0.035	28.6	0.11	25.4	0.05
		40S	28.6	0.09	11.1	0.045	28.6	0.23	25.4	0.06
		80S	28.6	0.11	11.1	0.055	28.6	0.38	25.4	0.09
		160S	28.6	0.15	11.1	0.07	28.6	0.28	25.4	0.10
		XXS	28.6	0.20	11.1	0.10	28.6	0.35	25.4	0.12
1	25	10S	38.1	0.14	22.2	0.07	38.1	0.27	38.1	0.09
		40S	38.1	0.16	22.2	0.08	38.1	0.35	38.1	0.10
		80S	38.1	0.20	22.2	0.10	38.1	0.50	38.1	0.13
		160S	38.1	0.30	22.2	0.15	38.1	0.48	38.1	0.17
		XXS	38.1	0.39	22.2	0.19	38.1	0.64	38.1	0.22
1-1/4	32	10S	47.6	0.23	25.4	0.12	47.6	0.45	38.1	0.13
		40S	47.6	0.26	25.4	0.13	47.6	0.65	38.1	0.17
		80S	47.6	0.35	25.4	0.175	47.6	0.90	38.1	0.19
		160S	47.6	0.45	25.4	0.22	47.6	0.94	38.1	0.23
		XXS	47.6	0.64	25.4	0.32	47.6	1.40	38.1	0.32
1-1/2	40	10S	57.2	0.30	28.6	0.15	57.2	0.65	38.1	0.14
		40S	57.2	0.40	28.6	0.20	57.2	0.88	38.1	0.20
		80S	57.2	0.55	28.6	0.275	57.2	1.50	38.1	0.23
		160S	57.2	0.70	28.6	0.35	57.2	1.30	38.1	0.30
		XXS	57.2	0.90	28.6	0.45	57.2	1.75	38.1	0.39
2	50	10S	76.2	0.50	34.9	0.25	63.5	0.90	38.1	0.17
		40S	76.2	0.70	34.9	0.35	63.5	1.10	38.1	0.27
		80S	76.2	0.95	34.9	0.475	63.5	2.15	38.1	0.30
		160S	76.2	1.40	34.9	0.70	63.5	2.25	38.1	0.45
		XXS	76.2	1.70	34.9	0.85	63.5	2.85	38.1	0.55
2-1/2	65	10S	95.3	0.85	44.5	0.43	76.2	1.10	38.1	0.25
		40S	95.3	1.40	44.5	0.70	76.2	1.70	38.1	0.35
		80S	95.3	1.50	44.5	0.75	76.2	3.00	38.1	0.45
		160S	95.3	2.30	44.5	1.15	76.2	3.60	38.1	0.60
		XXS	95.3	3.10	44.5	1.55	76.2	4.80	38.1	0.80
3	80	10S	114.3	1.25	50.8	0.63	85.7	1.40	50.8	0.40
		40S	114.3	2.50	50.8	1.25	85.7	1.90	50.8	0.71
		80S	114.3	2.90	50.8	1.45	85.7	3.80	50.8	0.85
		160S	114.3	4.10	50.8	2.05	85.7	5.30	50.8	1.20
		XXS	114.3	5.50	50.8	2.75	85.7	7.10	50.8	1.60
4	100	10S	152.4	2.10	63.5	1.10	104.8	2.15	63.5	0.65
		40S	152.4	4.00	63.5	2.00	104.8	4.15	63.5	1.22
		80S	152.4	6.00	63.5	3.00	104.8	7.65	63.5	1.60
		160S	152.4	9.90	63.5	4.95	104.8	10.90	63.5	2.60
		XXS	152.4	12.40	63.5	6.20	104.8	13.20	63.5	3.23
5	127	10S	190.5	3.65	79.2	1.53	123.8	3.50	76.2	1.02
		40S	190.5	6.80	79.2	3.40	123.8	6.60	76.2	2.00
		80S	190.5	9.30	79.2	4.65	123.8	13.50	76.2	2.70
		160S	190.5	15.00	79.2	7.50	123.8	16.20	76.2	4.30
		XXS	190.5	18.50	79.2	9.25	123.8	19.80	76.2	5.16
6	150	10S	228.6	5.45	95.3	2.72	142.9	4.80	88.9	1.36
		40S	228.6	11.00	95.3	5.50	142.9	9.80	88.9	3.23
		80S	228.6	16.80	95.3	8.40	142.9	19.30	88.9	4.40
		160S	228.6	26.00	95.3	13.00	142.9	25.10	88.9	6.96
		XXS	228.6	30.00	95.3	15.00	142.9	29.20	88.9	8.40
8	200	10S	304.8	10.25	127.0	5.15	177.8	8.60	101.6	2.49
		40S	304.8	22.00	127.0	11.00	177.8	18.00	101.6	5.67
		80S	304.8	34.80	127.0	17.40	177.8	33.00	101.6	8.35
		160S	304.8	61.00	127.0	30.50	177.8	55.00	101.6	14.20
		XXS	304.8	59.00	127.0	29.50	177.8	53.00	101.6	12.50
10	250	10S	381.0	19.50	159.0	9.75	215.9	14.50	127.0	4.90
		40S	381.0	41.00	159.0	20.50	215.9	31.00	127.0	9.21
		80S	381.0	53.90	159.0	26.95	215.9	60.00	127.0	13.60
		160S	381.0	110.00	159.0	50.00	215.9	98.00	127.0	30.20
		XXS	381.0	100.00	159.0	55.00	215.9	88.60	127.0	27.40
12	300	10S	457.2	27.25	190.5	13.63	254.0	22.00	152.4	6.53
		40S	457.2	60.00	190.5	30.00	254.0	44.50	152.4	15.00
		80S	457.2	80.00	190.5	40.00	254.0	78.00	152.4	22.50
		160S	457.2	174.00	190.5	87.00	254.0	153.00	152.4	42.20
		XXS	457.2	133.00	190.5	65.50	254.0	121.00	152.4	33.30
14	350	10S	533.4	39.95	222.2	19.50	279.4	49.00	165.1	8.20
		40S	533.4	70.00	222.2	35.00	279.4	102.00	165.1	16.00
		80S	533.4	94.00	222.2	47.00	279.4	115.00	165.1	27.00
		160S	533.4	228.00	222.2	114.00	279.4	202.00	165.1	62.50
		XXS	533.4		222.2		279.4		165.1	

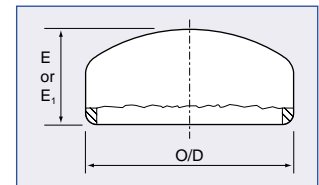
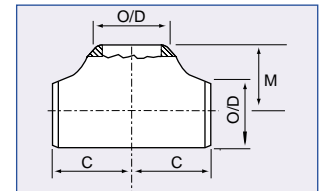
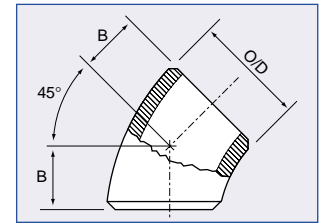
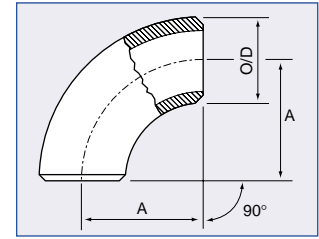

Note: Weights and dimensions listed above are a guide only. Dimensions in mm. Weights in kg. *There are 2 possible dimensions for this size, refer to ANSI B16.9 Weights and dimensions of larger Butt weld Fittings are available from your local Prochem office.

BUTTWELD FITTINGS WEIGHTS & DIMENSIONS

CONCENTRIC AND ECCENTRIC REDUCERS

WT SCH	NOMINAL SIZE		H	Wgt	NOMINAL SIZE		H	Wgt
	Inches OD1 X OD2	Metric OD1 X OD2			Inches OD1 X OD2	Metric OD1 X OD2		
10S	3/4 X 1/2	20 X 15	38.1	0.03	4 X 2	100 X 50	101.6	0.82
40S			38.1	0.07			101.6	1.60
80S			38.1	0.10			101.6	2.27
160S			38.1	0.14			101.6	4.52
XXS			38.1	0.14			101.6	4.52
10S	1 X 1/2	25 X 15	50.8	0.07	4 X 2-1/2	100 X 65	101.6	0.82
40S			50.8	0.13			101.6	1.60
80S			50.8	0.16			101.6	2.27
160S			50.8	0.25			101.6	4.52
XXS			50.8	0.25			101.6	4.52
10S	1 X 3/4	25 X 20	50.8	0.07	4 X 3	100 X 80	101.6	0.82
40S			50.8	0.13			101.6	1.60
80S			50.8	0.16			101.6	2.27
160S			50.8	0.25			101.6	4.52
XXS			50.8	0.25			101.6	4.52
10S	1-1/4 X 1	32 X 25	50.8	0.09	5 X 4	125 X 100	127.0	1.35
40S			50.8	0.18			127.0	2.75
80S			50.8	0.22			127.0	3.92
160S			50.8	0.42			127.0	8.00
XXS			50.8	0.42			127.0	8.00
10S	1-1/2 X 1	40 X 25	63.5	0.14	6 X 3	150 X 80	139.7	2.00
40S			63.5	0.26			139.7	3.95
80S			63.5	0.35			139.7	5.94
160S			63.5	0.66			139.7	11.50
XXS			63.5	0.66			139.7	11.50
10S	1-1/2 X 1-1/4	40 X 32	63.5	0.14	6 X 4	150 X 100	139.7	2.00
40S			63.5	0.26			139.7	3.95
80S			63.5	0.35			139.7	5.94
160S			63.5	0.66			139.7	11.50
XXS			63.5	0.66			139.7	11.50
10S	2 X 1	50 X 25	76.2	0.23	8 X 4	200 X 100	152.4	3.27
40S			76.2	0.41			152.4	6.50
80S			76.2	0.57			152.4	9.86
160S			76.2	1.12			152.4	18.55
XXS			76.2	1.12			152.4	18.55
10S	2 X 1-1/2	50 X 40	76.2	0.23	8 X 6	200 X 150	152.4	3.27
40S			76.2	0.41			152.4	6.50
80S			76.2	0.57			152.4	9.86
160S			76.2	1.12			152.4	18.55
XXS			76.2	1.12			152.4	18.55
10S	2-1/2 X 1-1/2	65 X 40	88.9	0.41	10 X 6	250 X 150	177.8	5.45
40S			88.9	0.77			177.8	10.70
80S			88.9	1.01			177.8	14.48
160S			88.9	2.00			177.8	33.40
XXS			88.9	2.00			177.8	33.40
10S	2-1/2 X 2	64 X 50	88.9	0.41	10 X 8	250 X 200	177.8	5.45
40S			88.9	0.77			177.8	10.70
80S			88.9	1.01			177.8	14.48
160S			88.9	2.00			177.8	33.40
XXS			88.9	2.00			177.8	33.40
10S	3 X 1-1/2	80 X 40	88.9	0.50	12 X 6	300 X 150	203.2	7.70
40S			88.9	1.00			203.2	15.00
80S			88.9	1.35			203.2	19.79
160S			88.9	2.73			203.2	53.00
XXS			88.9	2.73			203.2	53.00
10S	3 X 2	80 X 50	88.9	0.50	12 X 8	300 X 200	203.2	7.70
40S			88.9	1.00			203.2	15.00
80S			88.9	1.35			203.2	19.79
160S			88.9	2.73			203.2	53.00
XXS			88.9	2.73			203.2	53.00
10S	3 X 2-1/2	80 X 65	88.9	0.50	12 X 10	300 X 250	203.2	7.70
40S			88.9	1.00			203.2	15.00
80S			88.9	1.35			203.2	19.79
160S			88.9	2.73			203.2	53.00
XXS			88.9	2.73			203.2	53.00

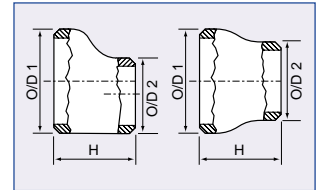

Note: Weights and dimensions listed above are a guide only. Dimensions in mm. Weights in kg. *There are 2 possible dimensions for this size, refer to ANSI B16.9 Weights and dimensions of larger Butt weld Fittings are available from your local Prochem office.